



# SGI InfiniteStorage 5600 (E5512) 12-Bay Controller Drive Tray Quick Install Guide

## 1 Before you begin

For warnings, refer to the printed *Safety Notices* document.



For detailed installation instructions, refer to *E5500 Controller-Drive Tray and Related Drive Trays* hardware installation guide.

For more information, refer to the *Initial Configuration and Software Installation Guide for SANtricity™ ES Storage Manager*.

### 1.1 What you need for assembly:

#### E5512 controller-drive tray:

- One two-unit (2U) -high E5512 controller-drive tray
- Two power cords
- Four Small Form-factor Pluggable (QSFP) transceivers, one for each of the host channel ports on the controllers (IB only)
- One cabinet mounting hardware kit, including:
  - Two mounting rails (right and left assemblies)
  - Eight M5 x 8 mm screws – Use six screws to secure the mounting rails and two screws to secure the front of the controller-drive tray to the cabinet.
  - Two M4 x 8 mm screws – Use the screws to secure the rear of the controller-drive tray to the mounting rails.

### Options:

- Drives (two minimum for each controller-drive tray)
- Ethernet cable (for out-of-band storage array management)
- Two QSFP transceivers for each optical cable
- Two host channel adapters (HCAs), or two Infiniband adapters installed in each host
- Two SAS copper cables for each drive tray connection

If you have any questions about the firmware or your configuration, contact your Technical Support representative.

### Tools:

- A cart to hold the controller-drive tray and its components
- Labels for the cable connections
- A medium flat-blade screwdriver
- A No. 2 Phillips screwdriver
- Anti-static protection
- A flashlight

## 2 Install the mounting rails

You can install the controller-drive tray into an industry-standard cabinet.

There must be a minimum depth of 76 cm (30 in.) between the front EIA support rails and the rear EIA support rails.

### 2.1 Position the mounting rails in the cabinet.

- If you are installing the mounting rails above an existing tray, position the mounting rails directly above the tray.
- If you are installing the mounting rails below an existing tray, allow 8.9-cm (3.5-in.) vertical clearance for the E5512 controller-drive tray.

### 2.2 Starting with the left mounting rail, use a flat-blade screwdriver to loosen the two flat-head rail adjustment screws. Hold the front of the left mounting rail against the inside of the front cabinet-mounting flange, and then extend the rear of the mounting rail until it makes contact with the rear cabinet-mounting flange. The alignment pins at the rear of the mounting rail should slide into the holes at the rear of the cabinet.

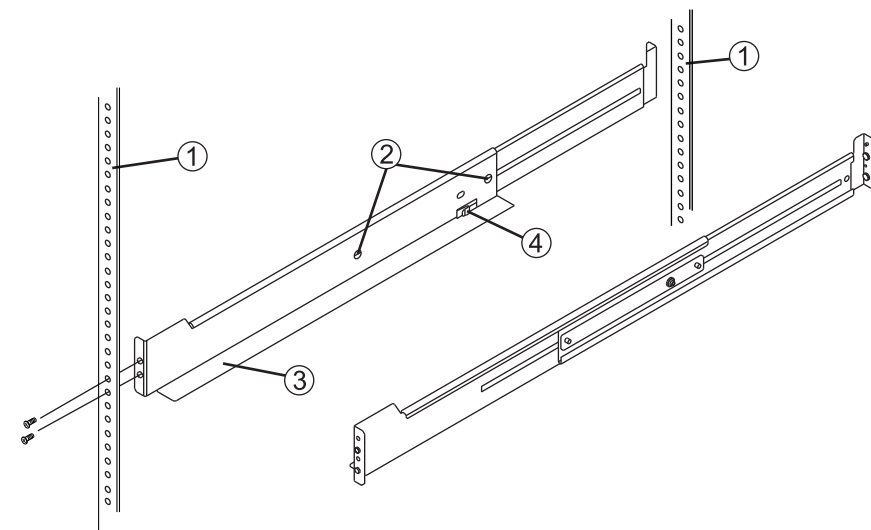

- 1 Mounting Holes on the Industry-Standard Cabinet
- 2 Adjustment Screws for Locking the Length of the Mounting Rail
- 3 Mounting Rail
- 4 Clip for Securing the Rear of the Controller-Drive Tray

### 2.3 From the front of the cabinet, with the mounting-rail flanges inside of the cabinet's mounting rail assemblies, use the Phillips screwdriver to loosely tighten only the lower screw.

### 2.4 From the rear of the cabinet, use the Phillips screwdriver to loosely tighten the two screws. Do not completely tighten the screws until you have installed the controller-drive tray in the cabinet.

### 2.5 Repeat step 2.2 through step 2.4 for the right mounting rail.

### 2.6 Tighten the flat-head rail adjustment screws on both mounting rails.

## 3 Install the controller-drive tray



**WARNING (W08) Risk of bodily injury**

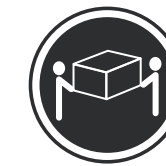

>18 kg (39.7 lbs)

Two persons are required to safely lift the component.

### 3.1 With the help of one other person, remove the controller-drive tray from the shipping box.

#### E5512 Controller-Drive Tray – Front View

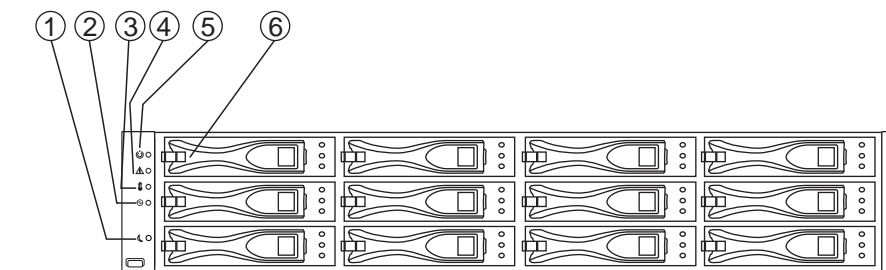

- 1 Standby Power LED
- 2 Power LED
- 3 Over-Temperature LED
- 4 Service Action Required LED
- 5 Locate LED
- 6 Drive Canister

#### E5512 Controller-Drive Tray – Rear View with SAS HIC

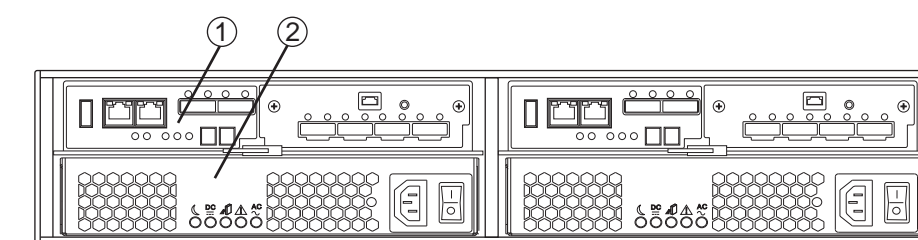

- 1 Controller Canister
- 2 Power-Fan Canister

#### E5512 Controller-Drive Tray – Rear View with InfiniBand HIC

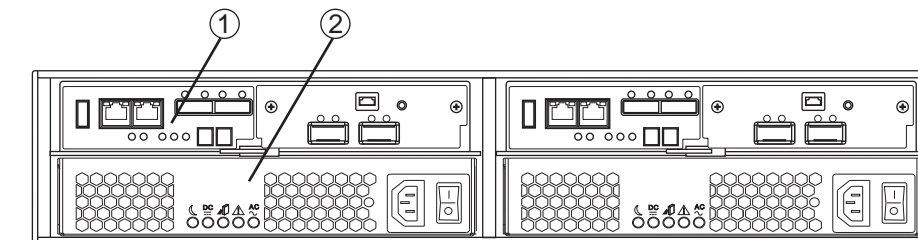

- 1 Controller Canister
- 2 Power-Fan Canister

### 3.2 With the help of one other person, slide the rear of the controller-drive tray onto the mounting rails so that the mounting holes on the front flanges of the controller-drive tray align with the mounting holes on the front of the mounting rails.

## 4 Secure the controller-drive tray



**WARNING (W18) Risk of bodily injury** – Do not use equipment in the cabinet as a shelf or workspace.



### 4.1 Secure the screws in the top mounting holes and the bottom mounting holes on each side of the controller-drive tray (refer to the image at the top of the next column).

You will install the DE5600 drive trays and the DE1600 drive trays below and above the controller-drive tray, keeping the weight in the lower portion of the cabinet. For the maximum number of drives supported in a particular configuration, see the *E5500 Controller-Drive Tray and Related Drive Trays* hardware installation guide.

#### E5512 Controller-Drive Tray

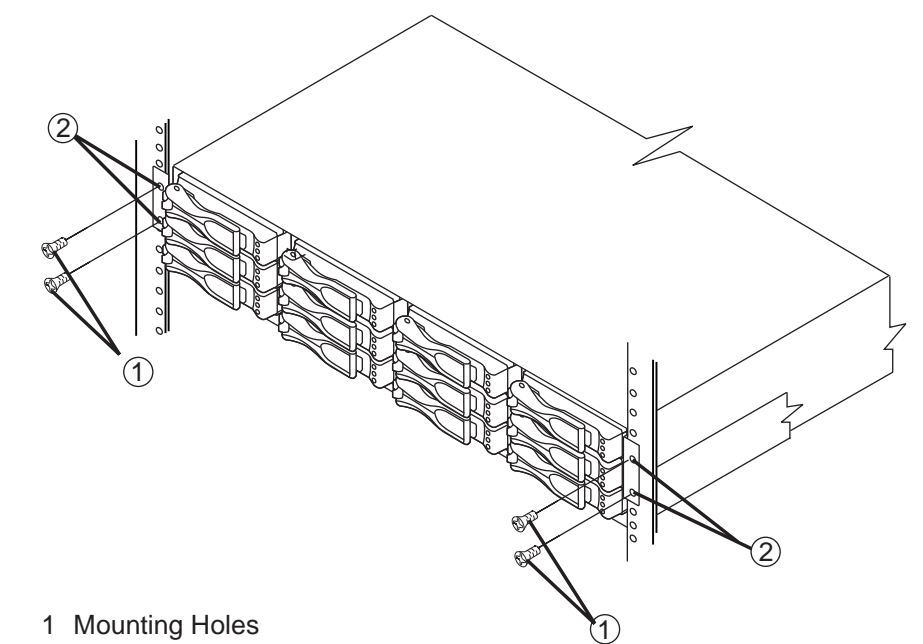

- 1 Mounting Holes
- 2 Screws

### 4.2 Secure the rear of the controller-drive tray to the cabinet by using two screws to attach the flanges on each side at the rear of the controller-drive tray to the mounting rails.

### 4.3 Install the front end caps on the front of the controller-drive tray by pressing the front end caps into place on the left side and the right side.

## 5 Connect the cables



**WARNING (W03) Risk of exposure to laser radiation** – Do not disassemble or remove any part of a Small Form-factor Pluggable (SFP) transceiver because you might be exposed to laser radiation.

**ATTENTION Potential damage to equipment (Network Telecommunications Equipment (NEBS) Ethernet cable installations only)** – The intra-building port(s) (Ethernet maintenance ports) of this equipment is suitable for connection to intra-building or unexposed wiring or cabling only. The intra-building port(s) of this equipment must not be metallically connected to interfaces that connect to the Outside Plant (OSP) or its wiring. These interfaces are designed for use as intra-building interfaces only (Type 2 or Type 4 ports as described in GR-1089-CORE) and require isolation from the exposed OSP cabling. The addition of Primary Protectors is not sufficient protection in order to connect these interfaces metallically to OSP wiring.

The cable shall be Shielded Twisted Pair (STP) and must be grounded at both ends to meet the intra-building lightning requirements from section 4.6.9.2 of GR-1089-CORE, Issue #5.

In this step, you will connect the E5512 controller-drive tray to the host or hosts, and then you will connect the DE5600 drive tray or the DE1600 drive tray to either a E5512 controller-drive tray (which contains the controllers), or to another DE5600 drive tray or DE1600 drive tray in the storage array (step 5.5). For more information, refer to these documents:

- *Quick Install Guide for the DE5600 Drive Tray*
- *Quick Install Guide for the DE1600 Drive Tray*
- *Quick Install Guide for the DE6600 Drive Tray*
- *E5500 Controller-Drive Tray and Related Drive Trays* hardware installation guide

## Host-to-Controller Cabling

- 5.1** Attach the appropriate cables and components for the relevant protocol (SAS or IB).

### E5512 Controller-Drive Tray Host and Drive Connections

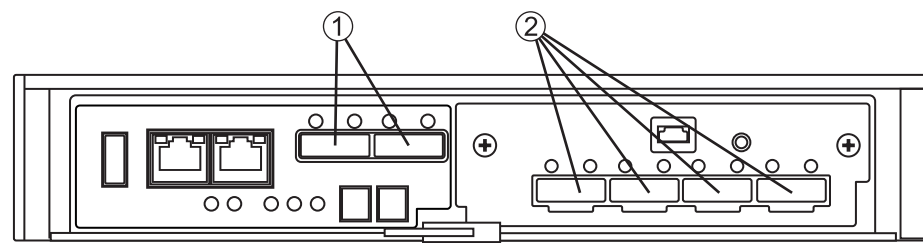

- 1 SFF-8088 SAS Channels 1 and 2 (Drive Expansion)  
2 Mini-SAS Host Interface Card Ports 1 - 4

**NOTE** This image shows both the drive channels and the host ports for an E5512 controller-drive tray with a SAS host interface card (HIC). If your system contains an IB HIC, there are only two ports on the right side.

- 5.2** Choose the host connection configuration.

- **Direct topology** – Connect the cable from the host port on the controller to either an InfiniBand HCA port or a SAS port on the host. The figure in step 5.4 shows the HBA port option on the host.
- **Switch or fabric topology** – Connect the cable from the host port on the controller to a port on the switch, and make sure that the HBA and the controller are in the same zone on the switch.
- **Mixed topology** – Use a combination of direct topology and fabric topology.

- 5.3** Repeat step 5.1 through step 5.2 for each controller and host channel that you intend to use.

- 5.4** When you are finished, label each end of the cable with information about its connection. This information is valuable should you need to disconnect cables to service a controller.

For specific information about using a mixed topology and a more detailed description of all cabling options, refer to either the *E5500 Controller-Drive Tray and Related Drive Trays* hardware installation guide or the *Hardware Cabling Guide*.

### Direct Topology – Two Hosts and a Dual Controller-Drive Tray for Maximum Redundancy

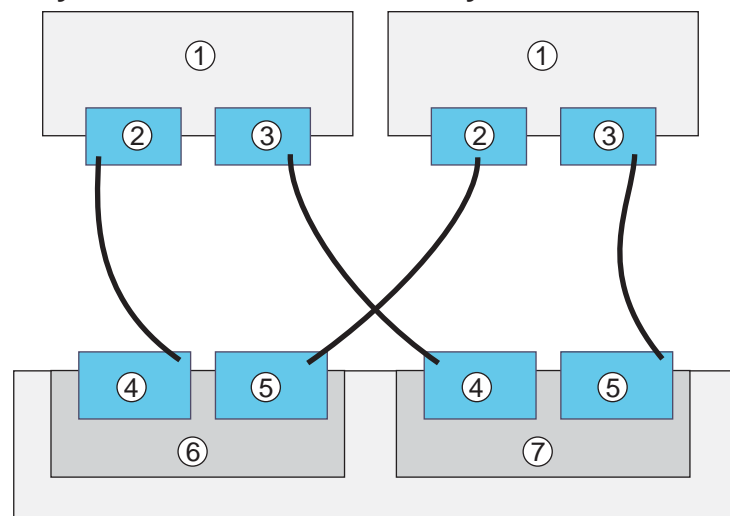

- 1 Host  
2 HBA 1 or NIC 1  
3 HBA 2 or NIC 2  
4 Host Port 1  
5 Host Port 2  
6 Controller A  
7 Controller B

### Fabric Topology – Two Hosts and a Dual Controller-Drive Tray for Maximum Redundancy Connected by a Switch

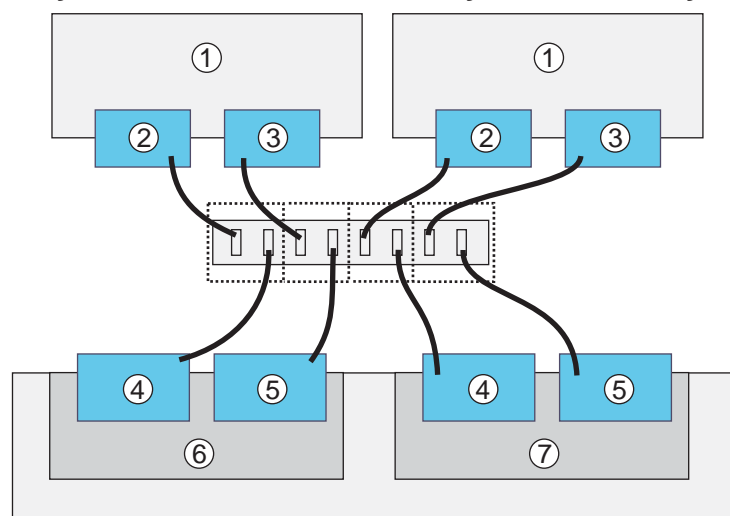

- 1 Host  
2 HBA 1 or NIC 1  
3 HBA 2 or NIC 2  
4 Host Port 1  
5 Host Port 2  
6 Controller A  
7 Controller B

Attach the cables to the drive trays as needed. For maximum redundancy and tray loss protection, see the following figure.

- 5.5** Attach the cables to the drive trays as needed. For maximum redundancy and tray loss protection, see the following figure. Refer to the *Hardware Cabling Guide* for detailed information.

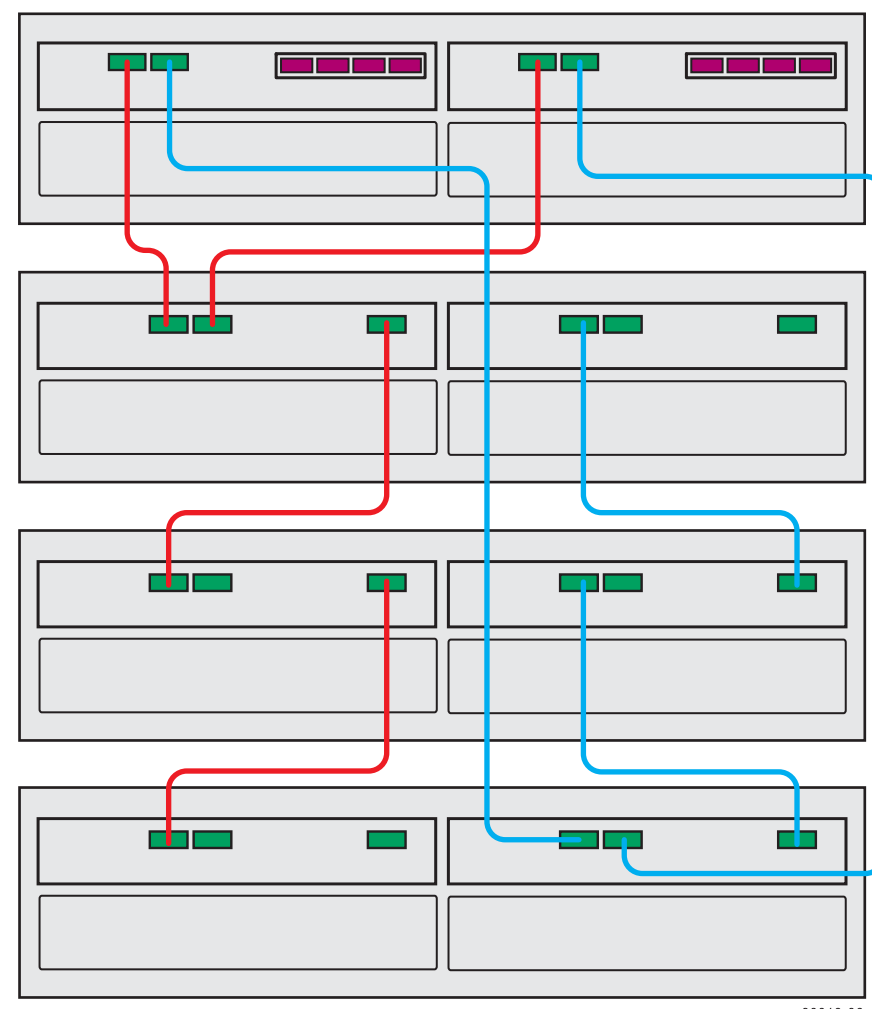

### Steps to connect Ethernet cables for out-of-band management only:

- 5.6** Connect one end of the Ethernet cable to the Ethernet port 1 connector on controller A.
- 5.7** Connect the other end of the Ethernet cable to the appropriate Ethernet network connection or directly to your Ethernet ports on your management station.
- 5.8** Repeat step 5.6 through step 5.7 for controller B.

## 6 Turn on the AC power

You must follow the power sequence in the order shown for turning on AC power to controller-drive trays and drive trays that use AC power. To establish power redundancy for trays with two power supplies, use at least two different power distribution units (PDUs) in the cabinet. Split the power connections from each tray into the separate PDUs. Then connect the PDUs to external power receptacles that are on different circuits.



**WARNING (W17) Risk of bodily injury** – Each tray has more than one power cord. To remove all electrical current from the devices, make sure that all of the power cords are disconnected from the power source.

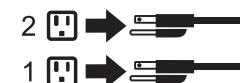

**IMPORTANT** You must turn on the power to all connected drive trays before you turn on the power for the E5512 controller-drive tray. Performing this action makes sure that the controllers recognize each attached drive tray.

- 6.1** Turn off all of the Power switches from the rear of the storage array, and make sure that all of the power cords are connected.
- 6.2** If the main AC circuit breaker switches in the cabinet are not already turned on, turn on the circuit breaker switches.
- 6.3** Turn on the Power switch on each power-fan canister in all of the installed drive trays.
- 6.4** Turn on both Power switches on each power-fan canister in the E5512 controller-drive tray.

**NOTE** When turning off the power to the storage array, perform the procedure in the reverse order. Turn off the power first to the controller-drive tray, and then turn off the power to the drive trays.

## 7 Determine the management method

Both management methods are specific to the installation steps in Section 9. This section and those that follow concern configuration of the entire storage array.

- **In-band management** – Managing a storage array by using a storage management station to send commands through the host input/output (I/O) connection to the controller.
- **Out-of-band management** – Managing a storage array by using a storage management station to send commands through the Ethernet connections on each controller.

For more information, refer to the “Deciding on the Management Method” step in the *Initial Configuration and Software Installation Guide for SANtricity ES Storage Manager*.

For out-of-band management, use one of the following methods to configure the controllers for network connectivity:

### Without a DHCP server

- 7.a1** Connect separate Ethernet cables to each controller.
- 7.a2** Manually configure the network settings on the controllers, using the guidelines and procedures from the “Manually Configuring the Controllers” step in the *Initial Configuration and Software Installation Guide for SANtricity ES Storage Manager*.

### With a DHCP server

- 7.b1** Connect separate Ethernet cables to each controller.
- 7.b2** Assign static IP addresses to the controllers.  
**NOTE** This method applies only to IPv4 networks.

### Stateless Address Autoconfiguration

- 7.c1** Connect separate Ethernet cables to each controller.  
**NOTE** This method applies only to IPv6 networks and does not require either a DHCP server or a router.

## 8 Install the software

Two types of computers are associated with the storage array.

- *Hosts* send I/O to the storage array.
- *Management stations* manage the storage array.

The type of operating system that the management station runs defines which SANtricity ES Storage Manager installation package you should install.

- 8.1** Refer to your storage vendor to find the appropriate operating system (OS) version of the SANtricity ES Storage Manager for your management station and attached hosts.
- Review the appropriate operating system and device driver *readme* files included with SANtricity ES Storage Manager for additional information.
  - For detailed information, consult the *Initial Configuration and Software Installation for SANtricity ES Storage Manager*.
- 8.2** Launch the SMIA executable file. Follow the instructions in the wizard, and select one of these installation methods:
- For the Management Station designated as a monitor (for monitoring and sending alert notifications), select **Management Station (full installation)**, and, when prompted, click **Automatically Start Monitor**.
  - For the Management Station that you will use to manage the storage array, select **Management Station**, and, when prompted, select **Do Not Automatically Start the Monitor**.
  - For all I/O hosts attached to the storage array, select **Host**, and, when prompted, select **Do Not Automatically Start the Monitor**. For Microsoft Windows and Linux operating systems, the *Initial Configuration and Software Installation for SANtricity ES Storage Manager* instructs you on installing failover software.
- 8.3** Check the BIOS and device driver versions for your current SAS HBA or InfiniBand HCA. If necessary, update them before proceeding. For both HBAs and HCAs, obtain the BIOS and device drivers directly from the vendor. For Microsoft Windows installations, install the MPIO multi-path driver on the host.

## 9 Discover the storage array

Before performing this step, make sure that you have correctly configured the storage array IP addresses as described in the *Initial Configuration and Software Installation Guide for SANtricity ES Storage Manager*.

- 9.1** Start the SANtricity ES Storage Manager software from your management station either by typing `SMclient` and pressing **Enter** (UNIX OSs), or by navigating to the directory that contains the `SMclient.exe` file, typing `SMclient`, and pressing **Enter** (Windows OSs). The client software starts and shows the Enterprise Management Window (EMW).
- 9.2** Select **Tools >> Automatic Discovery** from the EMW to discover the storage array.
- 9.3** In the configuration dialog, click **OK** to start the automatic discovery.
- 9.4** Click the **Devices** tab of the EMW to see the storage arrays.
- 9.5** Double-click the storage array that you want to manage. The associated Array Management Window (AMW) is launched.
- NOTE** To add a storage array from outside the local subnetwork, use the manual discovery method. From the EMW, click the **Add Storage Arrays** link, and follow the instructions.

## 10 Perform a basic setup

- 10.1** In the AMW, select the **Setup** tab, and select the **Rename Storage Array** link to name the storage array. You can use up to 30 alphanumeric characters, hyphens (-), pound signs (#), and underscores (\_).
- 10.2** Also on the **Setup** tab, click the **Locate Storage Array** link to find the storage array in the cabinet. A white LED blinks on the front of the selected storage array. Physically label the storage array with its name.
- 10.3** Click the **Storage & Copy Services** tab to see the storage array's configuration.  
If the storage array is not in the Optimal state, click the **Needs Attention** link. Follow the steps in the Recovery Guru.
- 10.4** Select the **Summary** tab, and select **Storage Array Profile**.  
By clicking the tabs, find the controller firmware, NVSRAM, ESM firmware, and firmware versions, and record them.
- 10.5** Close the storage array profile.

## 11 Configure the storage array

In the AMW, select the **Setup** tab. If the storage array is in the Optimal state, perform these tasks:

- 11.1** Configure the storage array.
- 11.2** Define the hosts.
- 11.3** Create new storage partitions.
- 11.4** Select **Monitor >> Health >> Collect Support Data**. Then name and specify a location on your system where you want to store the support bundle.
- 11.5** To set or change a password, in the AMW, select either the **Set a Storage Array Password** link under the **Setup** tab, or select **Storage Array >> Security >> Set Password**.

December 2012